

# **Basic master**

**No. 2948**

**Bedienungsanleitung**  
**Instruction manual • Mode d'emploi**  
**Istruzioni d'uso • Instrucciones para el servicio**  
**Инструкция по эксплуатации**  
**取扱説明書 • 사용 설명서 • 说明书**



# Basic master

No. 2948

ENGLISH

EN

1. Introduction.....	1
1.1 Employed Symbols.....	1
2. Safety.....	2
2.1 Intended use.....	2
2.2 Improper use.....	2
2.3 Environmental conditions for safe operation.....	2
2.4 Hazards and warnings.....	2
2.5 Authorised persons.....	3
2.6 Liability Exclusion.....	3
3. Product description.....	3
3.1 General description.....	3
3.2 Components and functional elements.....	3
3.3 Standard Delivery.....	4
3.4 Accessories.....	4
4. Commissioning.....	4
4.1 Installation.....	4
4.2 Foot switch connection.....	4
4.3 Compressed air connection.....	4
4.4 Electrical connection.....	5
4.5 Connection to suction device.....	5
4.6 Adjusting the Operating Pressure.....	5
4.7 Filling the Sandblasting Tanks.....	5
4.7.1 Authorised sandblasting material.....	5
5. Operation.....	6
5.1 Blasting Notes.....	6
5.2 Cold silanization in the sandblasting unit.....	6
6. Cleaning / Maintenance.....	6
6.1 Cleaning the Interior.....	6
6.2 Condensation.....	6
6.3 Blasting Nozzle Replacement.....	6
6.4 Cleaning the dosing nozzle.....	6
6.5 Lamp cover.....	7
6.6 Spare Parts.....	7
6.7 Shipping Notes.....	7
7. Trouble shooting.....	7
8. Technical Specifications.....	8
9. Warranty.....	8
10. Disposing of the Unit.....	8
10.1 Information on disposal for countries within the EC.....	8

## 1. Introduction

### 1.1 Employed Symbols

In these instructions or on the unit itself you will find symbols which have the following meaning:



#### **Danger**

This indicates an imminent risk of injury. Please observe the accompanying documents!



#### **Electrical hazard**

There is a risk of electrical shock.



#### **Attention**

Failure to observe the associated information can result in damage to the unit.



#### **Note**

The operating instructions contain useful information to make handling easier.



#### **Attention!**

Wear eye protection.



The unit complies with the relevant EC guidelines.



The unit is subject to the EC guidelines 2002/96/EG (WEEE Directive).

Further symbols are described by their uses.

## 2. Safety



Inform the operator about working procedures, possible operating hazards and actual operation of the unit with these user instructions.

Ensure that these instructions are available for the operator.

### 2.1 Intended use

The Basic line of sandblasting units are designed for use in dental laboratories to remove investment residues, oxides on cast objects, and for surface treatment.

Other areas of use also include divesting press ceramic or sandblasting porcelain occlusal surfaces.

### 2.2 Improper use

Only the fittings and spare parts supplied by Renfert may be used in this unit. The use of any other fittings is considered improper and carries the risk of severe injuries.

### 2.3 Environmental conditions for safe operation.

Safe operation of this unit can be guaranteed under the following conditions:

- Indoors,
- Up to an altitude of 2,000 m [6,500 ft] above sea level,
- At an ambient temperature of 5 - 40°C [41 - 104°F] \*),
- At a maximum relative humidity of 80% at 31°C [87.8°F], decreasing linearly to 50% relative humidity at 40°C [104°F] \*),
- With a mains power supply where current fluctuations do not exceed 10% of the nominal value,
- Under level 2 contamination conditions,
- Under overvoltage category II conditions.

\*) Between 5 – 30°C [41 - 86°F], the unit can be operated at a relative humidity of up to 80%. At temperatures between 31 - 40°C [87.8 - 104°F], the humidity must decrease proportionally in order to ensure operational readiness (e.g., at 35°C [95°F] = 65% humidity; at 40°C [104°F] = 50% humidity). The unit may not be operated at temperatures above 40°C [104°F].

### 2.4 Hazards and warnings

- ▶ If the unit is not used according to the instructions for use, then protection can no longer be guaranteed.
- ▶ The unit may only be used together with a mains cable with a country specific plug system. If a plug exchange is necessary, this may only be undertaken by a skilled electrician.
- ▶ The mains plug must be easy to access.
- ▶ Power supply cords and tubes (e.g. the mains cable) must be checked regularly for damage (e.g. kinks, cracks, porosity) or aging. Units with damaged power supply cords, tubes or other defects must not be used.
- ▶ Risk of Injury!  
If unauthorised attachments are used, there is a danger of injury. Only original Renfert fittings and accessories may be used.
- ▶ Please observe the accident prevention regulations provided by the „employer's liability insurance association“!
- ▶ Always disconnect the unit from the compressed air and power sources prior to beginning any maintenance work.
- ▶ When working on the tank (filling up, cleaning, maintenance) wear protective glasses for protecting your eyes.
- ▶ Any residue of abrasive material on the gasket may lead to leakage and early wear of the gasket. After filling up clean the thread and the gasket and close the lid properly.
- ▶ Solvents and tensides can create micro-cracking in the plastic (danger of explosion!). Clean the tank and the lid only with a dry cloth. Do not write or stick something on the tanks.
- ▶ Do not unscrew the tank lid as long as the pressure had not been released.
- ▶ Check the tanks and the lids regularly on damages and replace them in case of doubt.
- ▶ Check the tank cover for correct seating prior to beginning operation. Covers that are not securely closed can suddenly be blown off as the tank pressure increases. The resulting flying parts and abrasive represent a serious hazard.
- ▶ Never operate the blasting units without suitable dust extraction and appropriate protective gear, as this could result in health hazards. The type of dust extraction should be selected on the basis of the dust being generated. Follow here absolutely EN 60335-2-69 appendix AA or ask the appropriate authorities.
- ▶ Improper use can result in the risk of eye or skin injuries.
- ▶ Never direct the blasting material towards eyes or unprotected areas of skin!
- ▶ Never work with the view screen open!
- ▶ Caution: Failure to wear proper eye protection can result in eye injury due to particles suspended in the air. Always wear proper eye protection to protect your vision!
- ▶ Do not employ the foot switch when only the compressed air supply hose is connected. The loose hose could wrap around itself and cause serious injury.

## 2.5 Authorised persons

This product may only be used by persons over the age of 14. Operation and service may only be carried out by trained personnel. Repairs which are not described in these instructions may only be carried out by skilled electricians and the specialist dealers.

## 2.6 Liability Exclusion

Renfert GmbH shall be absolved from all claims for damages or warranty if:

- ▶ The product is employed for any purposes other than those cited in the operating instructions.
- ▶ The product is altered in any way other than those alterations described in the operating instructions.
- ▶ The product is repaired by other than an authorized facility or if any but Renfert OEM parts are employed.
- ▶ The product continues to be employed, despite obvious safety faults.
- ▶ In the case of mechanical impact or if the unit is dropped.
- ▶ Accessories or consumer products used, which are not supplied or authorised by Renfert GmbH.

## 3. Product description

### 3.1 General description

The Basic line of sandblasting units are designed for use in dental laboratories to remove investment residues, oxides on cast objects, and for surface treatment.

### 3.2 Components and functional elements

- |                        |                               |
|------------------------|-------------------------------|
| 1 Pressure regulator   | 12 Power cord                 |
| 2 Appliance socket     | 13 Foot switch                |
| 3 ON/OFF switch        | 14 Sandblasting tank          |
| 4 Tank lid             | 15 Air connection             |
| 5 Pressure gauge       | 16 Water trap                 |
| 6 Selector switch      | 16a Water trap valve          |
| 7 Protection screen    | 17 Foot switch connection (A) |
| 8 Hand piece           | 18 Foot switch connection (B) |
| 9 Base grid            | 19 Mixing chamber             |
| 10 Hand sleeves        | 20 Filter cartridge           |
| 11 Compressed air tube | 21 Suction tube               |

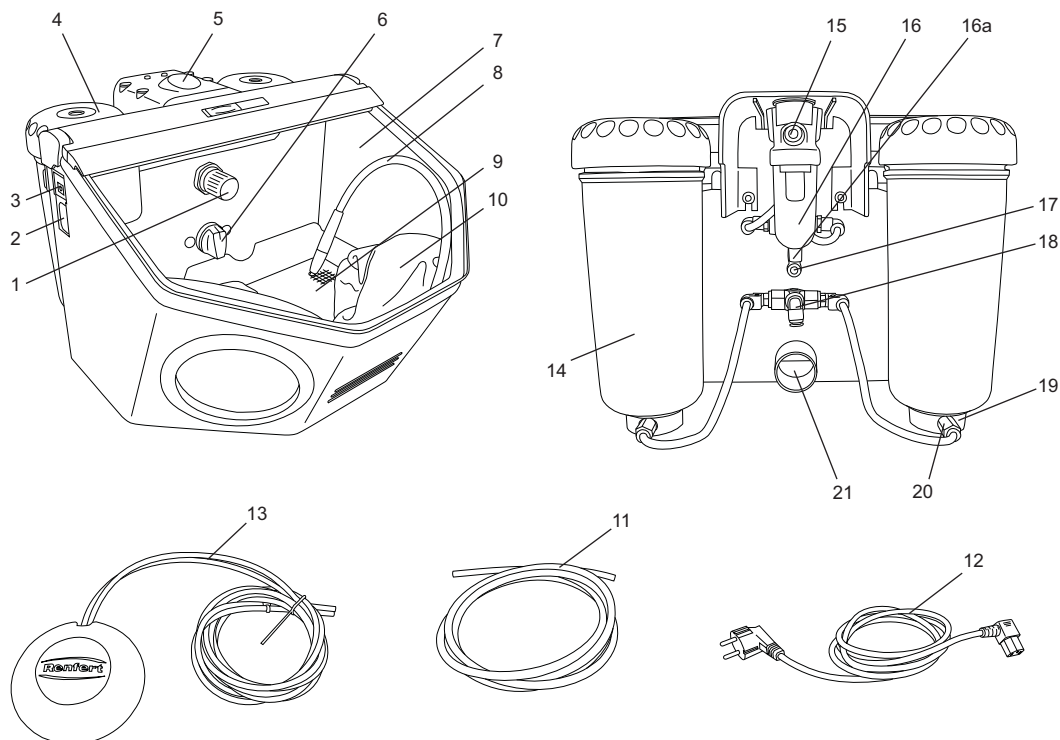

fig. 1

### 3.3 Standard Delivery

- 1 Basic master
- 1 Foot switch
- 1 Connection set
- 1 Set of Operating Instructions, with attachment
- 1 Power cord

### 3.4 Accessories

#### Abrasives

##### **Cobra aluminium oxide**

1594-1105	25 µm [500 mesh], white 5 kg canister
1594-1205	50 µm [270 mesh], white 5 kg canister
1594-2220	50 µm [270 mesh], white 20 kg bucket
1584-1005	90 µm [170 mesh], white 5 kg canister
1583-1005	110 µm [150 mesh], white 5 kg canister
1583-1020	110 µm [150 mesh], white 20 kg bucket
1587-1005	125 µm [115 mesh], pink 5 kg canister
1587-1020	125 µm [115 mesh], pink 20 kg bucket
1585-1005	250 µm [60 mesh], white 5 kg canister
1585-1020	250 µm [60 mesh], white 20 kg bucket

##### **Rolloblast glass beads**

1594-1305	50 µm [400-200 mesh] 5 kg canister
1594-2312	50 µm [400-200 mesh] 12.5 kg canister
1589-1005	100 µm [170-100 mesh] 5 kg canister

#### Nozzles

##### **Round nozzles**

90002-1203	silver	0,4mm	[0,0158 inch]
90003-3213	gold	0,65mm	[0,0256 inch]
90002-1204	green	0,8mm	[0,0315 inch]
90003-3211	blue	1,0mm	[0,0394 inch]
90003-3214	red	1,2mm	[0,0473 inch]
90002-1205	brown	1,4mm	[0,0552 inch]
90002-1206	bronze	2,0mm	[0,0788 inch]

##### **Slotted nozzles**

90003-1739	light red	1,5x3,5mm	[0,0591x0,1379 inch]
------------	-----------	-----------	----------------------

## 4. Commissioning

### 4.1 Installation

Choose a stable and non-slip surface to stand the unit on.

### 4.2 Foot switch connection

- Remove the foot switch from its shipping location in the blasting chamber.
- Insert the end of the tube marked with an „A“ (13) as far as it will go into the tube connection point also marked with an „A“ (17) on the blasting unit.
- Insert the end of the tube marked with an „B“ (13) as far as it will go into the tube connection point also marked with an „B“ (18) on the blasting unit.

When inserting the tubes you will notice a slight resistance which must be overcome.

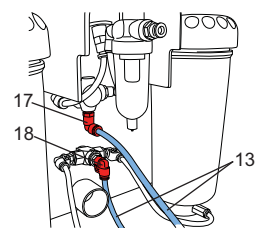

fig. 2

### 4.3 Compressed air connection

- Push the compressed air tube (11) onto the tube connection point (15) as far as it will go. In doing so there will be a slight resistance to overcome.
- To connect to the compressed air system, select the relevant tube coupling from the supplied set and attach this to the other end of the tube.
- Attach to the compressed air network.

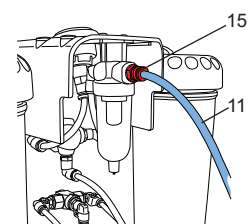

fig. 3

#### 4.4 Electrical connection



Ensure that the voltage information on the type plate and the mains voltage are compatible.

- Plug the mains cable (12) into the socket (2).
- Plug in the mains cable.

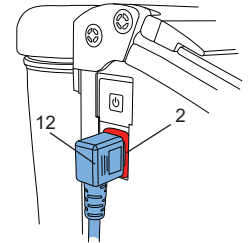

fig. 4

#### 4.5 Connection to suction device

- Plug the suction tube from the extraction unit to the suction pipe.(21).
- For suction devices with automatic activation: connect the mains plug from the sandblasting unit into the user socket on the suction device.

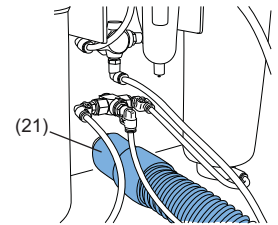

fig. 5

#### 4.6 Adjusting the Operating Pressure

- Activate the foot switch
- Set the sandblasting pressure (1-6 bar /14,5-87 psi) at the pressure regulator (1). The amount of pressure will be shown on the pressure gauge (5).

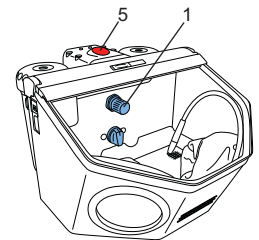

fig. 6

#### 4.7 Filling the Sandblasting Tanks



Attention: Never press the foot switch during filling.



*Even though the manometer may indicate pressure, the sandblasting tanks are only under pressure if the foot switch is engaged.*

- Add abrasive up to the maximum fill level (the point where the tank jacket thickens just below the thread).
- Reinstall the tank cover.



Before closing the tank, be sure to clean the threads in the cover and the tank to remove any abrasive residue.



Caution: Do not tilt the tank lid when unscrewing.

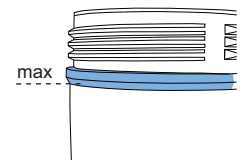

fig. 7

Always use only clean, dry abrasive of the appropriate grain size (refer to the accessories).

**The sandblasting unit is now operational.**

##### 4.7.1 Authorised sandblasting material

- Cobra (Renfert GmbH)
- Rolloblast (Renfert GmbH)
- ROCATEC (3M ESPE)

Sandblasting materials from other manufacturers may be used providing the grain size, grain shape and degree of purity comply with the above mentioned materials.

The company Renfert GmbH assumes no liability for function and durability of the units if other sandblasting material is used.

## 5. Operation

- Switch the illumination on (3).
- Select the blasting tank at the selection switch (6, fig.1).
- Take the respective hand piece from the selected blasting tank (see coloured marking).
- Activate the foot switch (13, fig.1).

The sandblasting material will flow as long as the foot switch is activated.

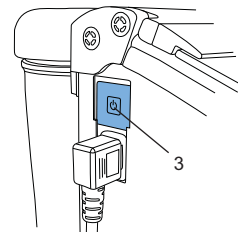

fig. 8

### 5.1 Blasting Notes

Flat blasting with wide nozzles:

90003-1739 1,5 x 3,5 mm [0,059 x 0,138 inch]

When blasting glass ceramics, refer to manufacturer's notes.

### 5.2 Cold silanization in the sandblasting unit

The Basic series of Renfert sandblasting units is exclusively recommended by 3M ESPE for use with ROCATEC™. This bonding system is ideal if an adhesive bond is required between a composite and a dental material (metal, acrylic, porcelain, zirconia porcelain).

**Advantage:** The surface film is applied cold, preventing thermal loading of metal frameworks and consequently the risk of distortion. All units in the Basic series can be used for ROCATEC™ due to their regular, homogeneous jet flow.

## 6. Cleaning / Maintenance



**Before cleaning or servicing:**

- ▶ Switch off and unplug the device!
- ▶ Disconnect the appliance from the compressed air supply!

### 6.1 Cleaning the Interior

- Use only solvent-free cleansers (e.g., soapy water).
- Remove the grate and vacuum the blasting chamber.
- Wipe out the tanks and lids only with a dry cloth!

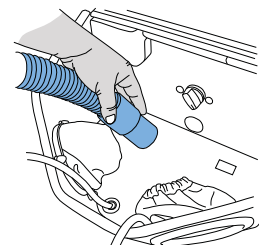

fig. 9

### 6.2 Condensation

- Inspect the water separator (16).
- Drain any water off through the valve (16a).

### 6.3 Blasting Nozzle Replacement

- For installation see accessory supplement

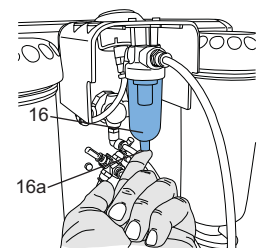

fig. 10

### 6.4 Cleaning the dosing nozzle

The dosing nozzle from the mixing chamber can become blocked due to contamination and moist blasting sand.

For cleaning, the dosing nozzle is removed using the supplied tool and replaced after cleaning.

- Vacuum clean the blasting tank completely.
- Hold the dosing nozzle with the tool and pull upwards (fig. 11).
- Clean the dosing nozzle (e.g. blow with compressed air).
- Replace dosing nozzle.

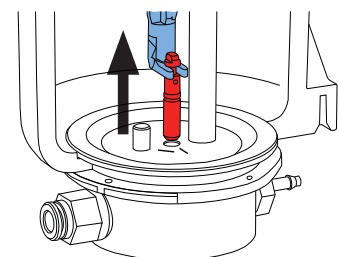

fig. 11



**Before remounting, the dosing nozzle should be completely dry!**

- The dosing nozzle must be adjusted with blasting tanks of 25-70µm (fig. 12)!



see also supplement „Cleaning the dosing nozzle“

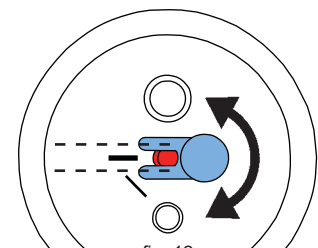

fig. 12

## 6.5 Lamp cover

In the course of time, the lamp cover can become matt. This cover can be ordered as a spare part.

## 6.6 Spare Parts

For the order numbers of consumables and spare parts please refer to the spare parts list at the end of this manual. Serial number, production date and unit version can all be found on the unit's type plate.

## 6.7 Shipping Notes

- Empty all blasting tanks.
- Order Renfert transport packaging (Tel. +49 7731 8208-383)

The return form can be downloaded from the „Advice“ section on the Renfert website at [www.renfert.com](http://www.renfert.com).

## 7. Trouble shooting

Problem	Possible cause	Corrective action
<b>No air and no abrasive.</b>	<ul style="list-style-type: none"> <li>• Blasting nozzle blocked at the hand-piece.</li> <li>• Foot switch connecting lines kinked.</li> <li>• Tank selection switch in an intermediate position.</li> </ul>	<ul style="list-style-type: none"> <li>• Unscrew the nozzle from the hand-piece and blow it out.</li> <li>• With the nozzle removed, blow out the blasting hose by activating the foot pedal.</li> <li>• Inspect/correct the connection lines.</li> <li>• Turn the switch until you feel it click into place.</li> </ul>
<b>Only air, no or very little abrasive.</b>	<ul style="list-style-type: none"> <li>• The dosage nozzle in the mixing chamber is blocked due to contaminated or moist sand.</li> </ul>	<ul style="list-style-type: none"> <li>• Cleaning the dosing nozzle, see chapter 6.4</li> </ul>
<b>Only air, no or very little abrasive.</b>	<ul style="list-style-type: none"> <li>• Mixing chamber filter combination blocked.</li> <li>• Abrasive contains impurities or is moist.</li> </ul>	<ul style="list-style-type: none"> <li>• Change filter cartridge (20/fig. 1) (Wrench SW14)</li> <li>• Replace the abrasive.</li> </ul>
<b>Unit blasts continuously.</b>	<ul style="list-style-type: none"> <li>• Foot switch connected incorrectly.</li> <li>• Valve in foot switch is defective.</li> </ul>	<ul style="list-style-type: none"> <li>• Inspect/correct the foot switch connection.</li> <li>• Replace foot switch.</li> </ul>
<b>Lamp is not alight.</b>	<ul style="list-style-type: none"> <li>• Power cord not plugged in</li> <li>• Illumination defect</li> </ul>	<ul style="list-style-type: none"> <li>• Plug the power cord into the wall outlet.</li> <li>• Change light using the service or see spare part list.</li> </ul>
<b>Compressed air leaking from the foot switch.</b>	<ul style="list-style-type: none"> <li>• Pneumatic hoses reversed.</li> </ul>	<ul style="list-style-type: none"> <li>• Reverse the connections.</li> </ul>
<b>Foot switch fails to switch on.</b>	<ul style="list-style-type: none"> <li>• No pressure at the compressed air connection.</li> <li>• Pneumatic hoses are kinked.</li> </ul>	<ul style="list-style-type: none"> <li>• Inspect the compressed air lines and/or the compressor.</li> <li>• Reposition the hoses.</li> </ul>
<b>Foot switch hoses cannot be disconnected from the unit.</b>	<ul style="list-style-type: none"> <li>• Push-in connection is not released (Fig. 2).</li> </ul>	<ul style="list-style-type: none"> <li>• Press the push-in connection ring on the hose side firmly while pulling on the hoses.</li> </ul>



## 8. Technical Specifications

Working pressure:	1 - 8 bar [14,5 - 116 psi]
Connecting pressure, external:	5 - 8 bar [73 - 116 psi]
Air consumption:	98 l/min. at 6 bar [87 psi]
Voltage:	230 V, 50/60 Hz 100-120 V, 50/60 Hz
Lamp power consumption:	16 W
Cable length:	2 m [78,74 inch]
Ø hose connection:	interior: 4 mm [0,16 inch] exterior: 6 mm [0,24 inch]
Ø size of pipe union for external extraction unit:	interior: 35 mm [1,38 inch] exterior: 40 mm [1,58 inch]
Dimensions (WxHxD):	395 x 285 x 460 mm [15,55 x 11,22 x 18,11 inch]
Blasting chamber volume:	20 l
Tank capacity:	1000 ml each
Weight (empty):	ca. 8,1 kg
Noise level according to DIN 45635-01-KL3:	< 72 dB(A)

EN

## 9. Warranty

Provided the unit is properly used, Renfert warrants all parts of the *Basic master* for a **period of 3 years**. In case of any claims for warranty original dealers' invoice is required.

Parts which are subject to natural wear and tear such as consumer products are excluded from the guarantee (e.g. sandblasting nozzles, blasting tubes, connections for the blasting tubes, viewing panels, filter materials, etc.).

The warranty is voided in case of improper use; failure to observe the operating, cleaning, maintenance, and connection instructions; in case of independent repairs or repairs by unauthorized personnel; if spare parts from other manufacturers are employed, or; in case of unusual influences or influences not in compliance with the utilization instructions. Warranty service shall not extend the original warranty.

## 10. Disposing of the Unit

The unit must be disposed of by an authorized recycling operation. The selected firm must be informed of all possibly health-hazardous residues in the unit.

### 10.1 Information on disposal for countries within the EC

To conserve and protect the environment, prevent environmental pollution and improve the recycling of raw materials, the European Commission adopted a directive that requires the manufacturer to accept the return of electrical and electronic units for proper disposal or recycling.

Within the European Union units with this symbol should not therefore be disposed of in unsorted domestic waste.



For more information regarding proper disposal please apply at your local authorities.